

Article number: 20274B48MZ2BL

Description: E+G Swivel clamp connector
GN274-B48-MZ-2-BL

Measures

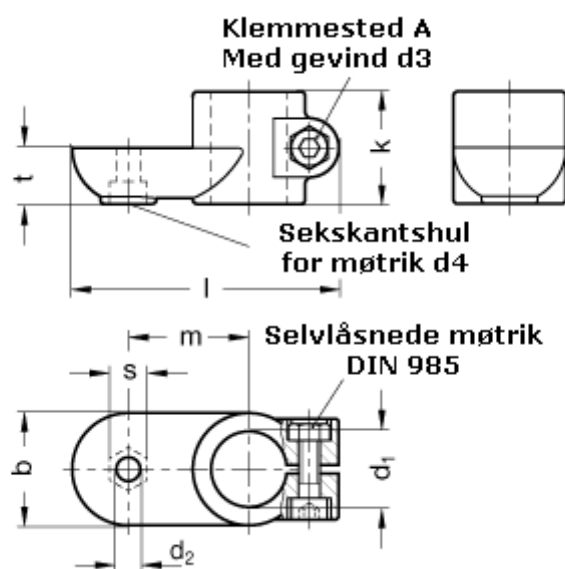

b = 65

s = 17

d1 = B48

t = 32.5

d2 = 10.5

d3 = M10

d4 = M10

k = 65

l = 148

m = 70